

TECHNICAL DATASHEET



EF REDUCED TEE 90°

04 Update - 04/2024

TECHNICAL DATA

Article No	001 117 2042 0129
d1 (mm)	125
d2 (mm)	63
D (mm)	158
Z (mm)	268
L (mm)	150
le1 (mm)	77
le2 (mm)	67
m (mm)	36
Weight (Kg)	1,975
Box Quantity (pcs)	6
Box Dimension (cm)	55x30x43,5

INJECTION MOULDED

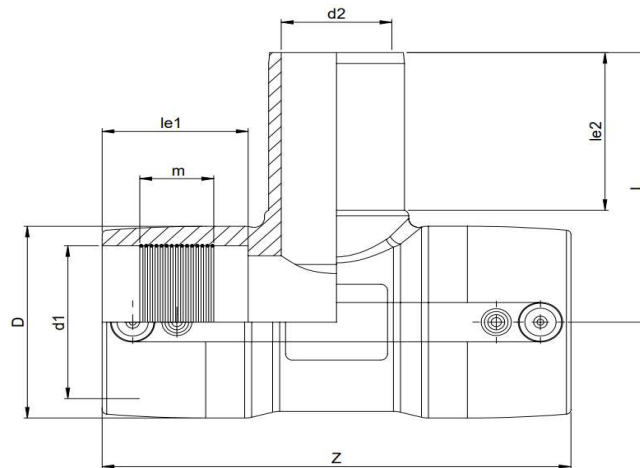

IDENTIFICATION OF PRODUCT

D(mm)	125-63
SDR	11
RAW MATERIAL	PE 100
PRESSURE CLASS	16 Bar Water 10 Bar Gas
TRADEMARK	NTG
EXECUTION	Injection Moulded
STANDARD	EN 12201-3 EN 1555-3 AS / NZS 4129
SPECIFICATION	Suitable for SDR9...17 pipe 4 mm pin connectors

EF SPECIFICATION

WELDING VOLTAGE	40V
RESISTANCE	1,15 Ω
WELDING TIME	300 Sec.
COOLING TIME	15 Min.
WINDING TYPE	Monofilar
WELDING BARCODE	



971420321253401156300119

Tolerance on diameters and thickness according to the standards. The other dimensions are specialized. Tolerance $\pm 5\%$. NTG PLASTIK reserves all the right to change any information without giving prior notice. The production, distribution and utilization of this document without explicit authorization is prohibited.